

planet
ficha técnica
datasheet

ref. 5551232

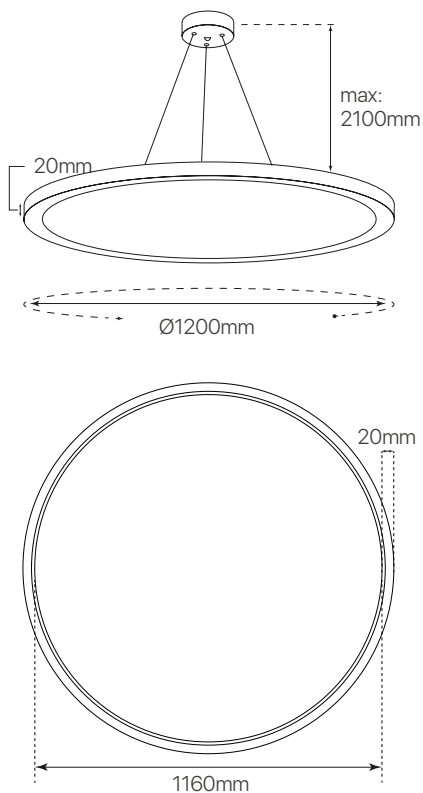

Nombre / Name	planet
Referencia / Reference	5551232
Materiales / Materials	Aluminio + PMMA / Aluminum + PMMA
Difusor / Diffuser	PMMA
Potencia / Power	100W
Temperatura de color / Color temperature	6000K
Flujo luminoso / Luminous flux	9512lm
Dimable / Dimmable	No
Ángulo de apertura / Beam angle	120°
Ángulo de inclinación / Inclination angle	-
IP	20
I.K.	-
F.P	>0,9
UGR	20
IRC	>80
Chip	San'an 2835
Driver	LIFUD
Vida media (duración) / Average life	30,000h
Clase energética / Energy class	A+
Aislamiento eléctrico / Electrical isolation	Clase II
Colores / Colors	Blanco
Medida exterior / Product size	1200mm x 20mm
Protección contra Sobretensiones / surge protection	4kV
Tª (ambiente/trabajo) / Tª (environment/work)	-20°C~50°C
Input	AC170~265V
Output	DC33~42V
Frecuencia / Frequency	50/60Hz
Peso / Weight	11,80 kg
Certificados / Certificates	CE
Garantía / Warranty	2 años / 2 years